



W65C02S
Microprocessor
DATA SHEET



WDC reserves the right to make changes at any time without notice in order to improve design and supply the best possible product. Information contained herein is provided gratuitously and without liability, to any user. Reasonable efforts have been made to verify the accuracy of the information but no guarantee whatsoever is given as to the accuracy or as to its applicability to particular uses. In every instance, it must be the responsibility of the user to determine the suitability of the products for each application. WDC products are not authorized for use as critical components in life support devices or systems. Nothing contained herein shall be construed as a recommendation to use any product in violation of existing patents or other rights of third parties. The sale of any WDC product is subject to all WDC Terms and Conditions of Sales and Sales Policies, copies of which are available upon request.

Copyright ©1981-2004 by The Western Design Center, Inc. All rights reserved, including the right of reproduction, in whole, or in part, in any form.



TABLE OF CONTENTS

1 INTRODUCTION.....5
1.1 FEATURES OF THE W65C02S.....5
2 FUNCTIONAL DESCRIPTION.....6
2.1 INSTRUCTION REGISTER (IR) AND DECODE.....6
2.2 TIMING CONTROL UNIT (TCU).....6
2.3 ARITHMETIC AND LOGIC UNIT (ALU).....6
2.4 ACCUMULATOR REGISTER (A).....6
2.5 INDEX REGISTERS (X AND Y).....6
2.6 PROCESSOR STATUS REGISTER (P).....6
2.7 PROGRAM COUNTER REGISTER (PC).....6
2.8 STACK POINTER REGISTER (S).....7
3 PIN FUNCTION DESCRIPTION.....9
3.1 ADDRESS BUS (A0-A15).....9
3.2 BUS ENABLE (BE).....9
3.3 DATA BUS (D0-D7).....9
3.4 INTERRUPT REQUEST (IRQB).....9
3.5 MEMORY LOCK (MLB).....9
3.6 NON-MASKABLE INTERRUPT (NMIB).....9
3.7 NO CONNECT (NC).....10
3.8 PHASE 2 IN (PHI2), PHASE 2 OUT (PHI2O) AND PHASE 1 OUT (PHI1O).....10
3.9 READ/WRITE (RWB).....10
3.10 READY (RDY).....10
3.11 RESET (RESB).....11
3.12 SET OVERFLOW (SOB).....11
3.13 SYNCHRONIZE WITH OP CODE FETCH (SYNC).....11
3.14 POWER (VDD) AND GROUND (VSS).....11
3.15 VECTOR PULL (VPB).....11
4 ADDRESSING MODES.....16
4.1 ABSOLUTE A.....16
4.2 ABSOLUTE INDEXED INDIRECT (A,X).....16
4.3 ABSOLUTE INDEXED WITH X A,X.....16
4.4 ABSOLUTE INDEXED WITH Y A, Y.....17
4.5 ABSOLUTE INDIRECT (A).....17
4.6 ACCUMULATOR A.....17
4.7 IMMEDIATE ADDRESSING #.....17
4.8 IMPLIED I.....17
4.9 PROGRAM COUNTER RELATIVE R.....18
4.10 STACKS.....18
4.11 ZERO PAGE ZP.....18
4.12 ZERO PAGE INDEXED INDIRECT (ZP,X).....18
4.13 ZERO PAGE INDEXED WITH X ZP,X.....19
4.14 ZERO PAGE INDEXED WITH Y ZP, Y.....19
4.15 ZERO PAGE INDIRECT (ZP).....19
4.16 ZERO PAGE INDIRECT INDEXED WITH Y (ZP), Y.....19
5 OPERATION TABLES.....21
6 DC, AC AND TIMING CHARACTERISTICS.....23



6.1 DC CHARACTERISTICS TA = -40°C TO +85°C (PLCC, QFP) TA= 0°C TO 70°C (DIP) 24

6.2 AC CHARACTERISTICS TA = -40°C TO +85°C (PLCC, QFP) TA= 0°C TO 70°C (DIP) 25

7 CAVEATS36

8 W65C02DB DEVELOPER BOARD AND37

IN-CIRCUIT EMULATOR (ICE).....37

8.1 FEATURES : 38

8.2 MEMORY MAP:..... 38

8.3 CROSS-DEBUGGING MONITOR PROGRAM..... 38

8.4 BUILDING..... 38

9 HARD CORE MODEL39

9.1 FEATURES OF THE W65C02S HARD CORE MODEL..... 39

10 SOFT CORE RTL MODEL39

10.1 W65C02 SYNTHESIZABLE RTL-CODE IN VERILOG HDL..... 39

TABLE OF TABLES

TABLE 3-1 VECTOR LOCATIONS12

TABLE 3-2 PIN FUNCTION TABLE.....12

TABLE 4-1 ADDRESSING MODE TABLE.....20

TABLE 5-1 INSTRUCTION SET TABLE21

TABLE 5-2 W65C02S OPCODE MATRIX22

TABLE 6-1 ABSOLUTE MAXIMUM RATINGS23

TABLE 6-2 DC CHARACTERISTICS.....24

TABLE 6-3 AC CHARACTERISTICS25

TABLE 6-4 OPERATION, OPERATION CODES AND STATUS REGISTER.....28

TABLE 6-5 INSTRUCTION TIMING CHART32

TABLE 7-1 MICROPROCESSOR OPERATIONAL ENHANCEMENTS36

TABLE OF FIGURES

FIGURE 2-1 W65C02S INTERNAL ARCHITECTURE SIMPLIFIED BLOCK DIAGRAM.....7

FIGURE 2-2 W65C02S MICROPROCESSOR PROGRAMMING MODEL8

FIGURE 3-1 W65C02S 40 PIN PDIP PINOUT13

FIGURE 3-2 W65C02S 44 PIN PLCC PINOUT14

FIGURE 3-3 W65C02S 44 PIN QFP PINOUT15

FIGURE 6-1 IDD VS VDD24

FIGURE 6-2 F MAX VS VDD24

FIGURE 6-3 GENERAL TIMING DIAGRAM26



1 INTRODUCTION

The W65C02S is a low power cost sensitive 8-bit microprocessor. The W65C02S is a fully static core and the PHI2 clock can be stopped when it is in the high (logic 1) or low (logic 0) state. The variable length instruction set and manually optimized core size makes the W65C02S an excellent choice for low power System-on-Chip (SoC) designs. The Verilog RTL model is available for ASIC design flows. WDC, a Fabless Semiconductor Company, provides packaged chips for evaluation or volume production. To aid in system development, WDC provides a Development System that includes a W65C02DB Developer Board, an In-Circuit Emulator (ICE) and the W65cSDS Software Development System, see www.westerndesigncenter.com for more information.

1.1 Features of the W65C02S

- 8-bit data bus
- 16-bit address bus provides access to 65,536 bytes of memory space
- 8-bit ALU, Accumulator, Stack Pointer, Index Registers, Processor Status Register
- 16-bit Program Counter
- 69 instructions
- 16 addressing modes
- 212 Operation Codes (OpCodes)
- Vector Pull (VPB) output indicates when interrupt vectors are being addressed
- WAit-for-Interrupt (WAI) and SToP (STP) instructions reduce power consumption, decrease interrupt latency and provide synchronization with external events
- Variable length instruction set provides for lower power and smaller code optimization over fixed length instruction set processors
- Fully static circuitry
- Wide operating voltage range, 1.8+/- 5%, 2.5+/- 5%, 3.0+/- 5%, 3.3+/- 10%, 5.0+/- 5% specified
- Low Power consumption, 150uA@1MHz



2 FUNCTIONAL DESCRIPTION

The internal organization of the W65C02S is divided into two parts: 1) Register Section and 2) Control Section. Instructions obtained from program memory are executed by implementing a series of data transfers within the Register Section. Signals that cause data transfers are generated within the Control Section.

2.1 Instruction Register (IR) and Decode

The Operation Code (OpCode) portion of the instruction is loaded into the Instruction Register from the Data Bus and is latched during the OpCode fetch cycle. The OpCode is then decoded, along with timing and interrupt signals, to generate various control signals for program execution.

2.2 Timing Control Unit (TCU)

The Timing Control Unit (TCU) provides timing for each instruction cycle that is executed. The TCU is set to zero for each instruction fetch, and is advanced at the beginning of each cycle for as many cycles as is required to complete the instruction. Data transfers between registers depend upon decoding the contents of both the IR and the TCU.

2.3 Arithmetic and Logic Unit (ALU)

All arithmetic and logic operations take place within the ALU. In addition to data operations, the ALU also calculates the effective address for relative and indexed addressing modes. The result of a data operation is stored in either memory or an internal register. Carry, Negative, Overflow and Zero flags are updated following the ALU data operation.

2.4 Accumulator Register (A)

The Accumulator Register (A) is an 8-bit general purpose register which holds one of the operands and the result of arithmetic and logical operations. Reconfigured versions of this processor family could have additional accumulators.

2.5 Index Registers (X and Y)

There are two 8-bit Index Registers (X and Y) which may be used as general purpose registers or to provide an index value for calculation of the effective address. When executing an instruction with indexed addressing, the microprocessor fetches the OpCode and the base address, and then modifies the address by adding the Index Register contents to the address prior to performing the desired operation.

2.6 Processor Status Register (P)

The 8-bit Processor Status Register (P) contains status flags and mode select bits. The Carry (C), Negative (N), Overflow (V) and Zero (Z) status flags serve to report the status of ALU operations. These status flags are tested with Conditional Branch instructions. The Decimal (D) and IRQB disable (I) are used as mode select flags. These flags are set by the program to change microprocessor operations. Bit 5 is available for a user status or mode bit.

2.7 Program Counter Register (PC)

The 16-bit Program Counter Register (PC) provides the addresses which are used to step the microprocessor through sequential program instructions. This register is incremented each time an instruction or operand is fetched from program memory.

2.8 Stack Pointer Register (S)

The Stack Pointer Register (S) is an 8-bit register which is used to indicate the next available location in the stack memory area. It serves as the effective address in stack addressing modes as well as subroutine and interrupt processing.

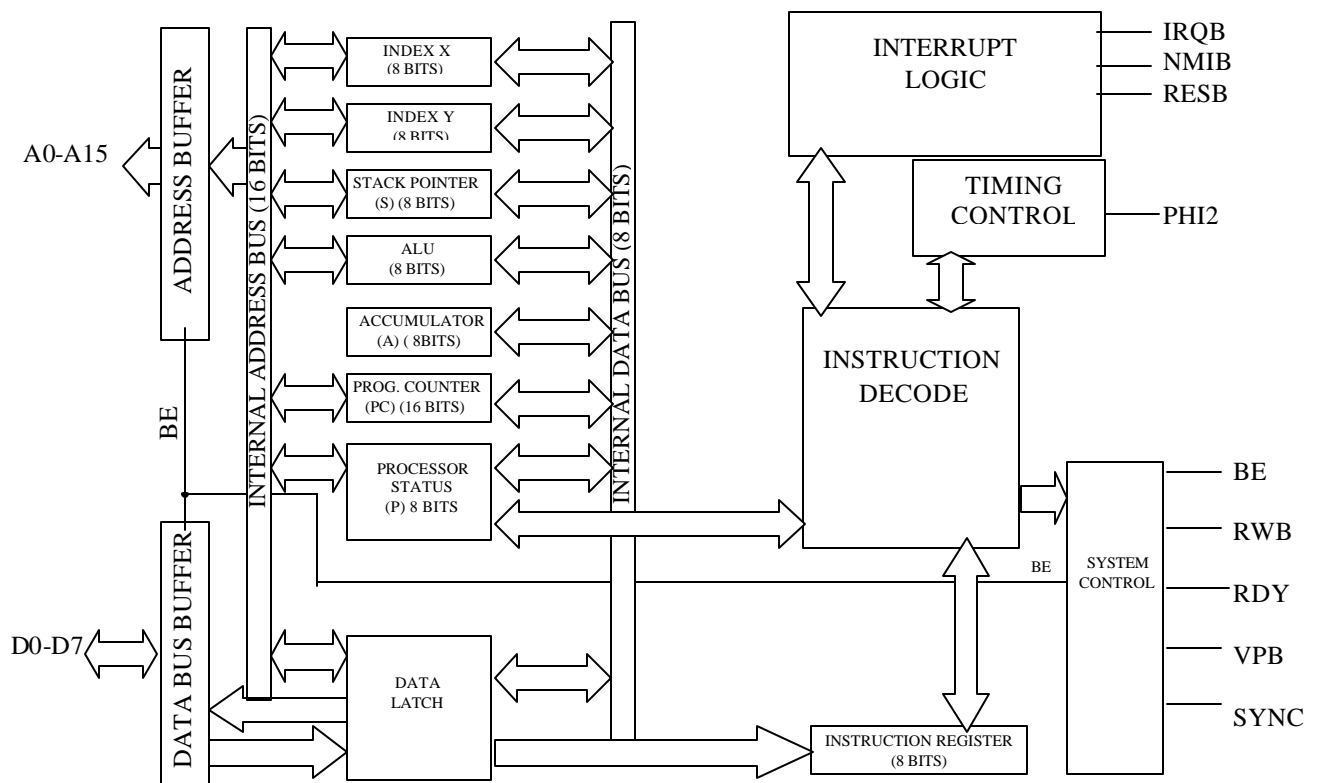

Figure 2-1 W65C02S Internal Architecture Simplified Block Diagram

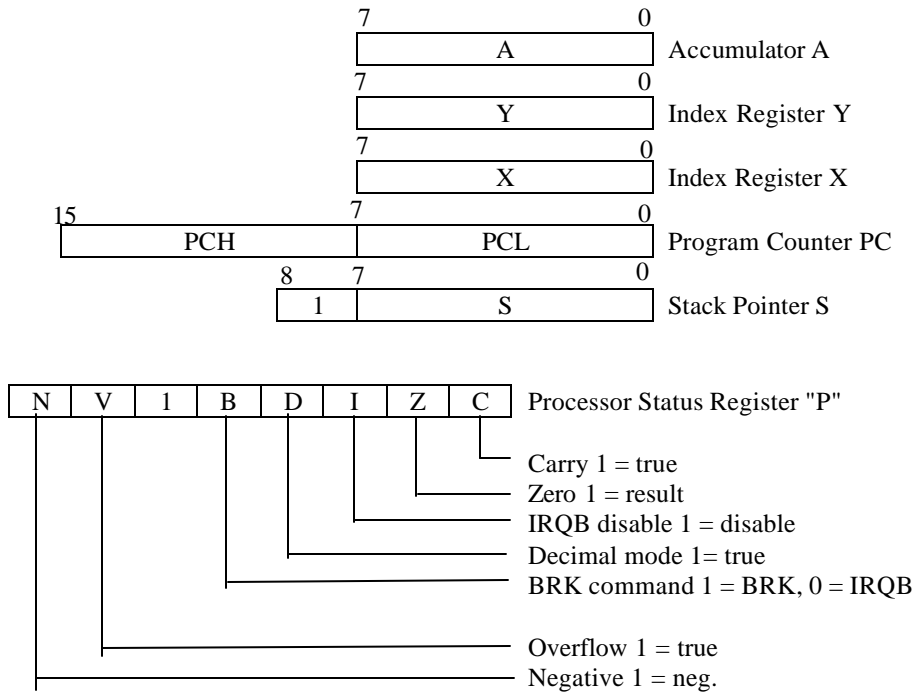

Figure 2-2 W65C02S Microprocessor Programming Model



3 PIN FUNCTION DESCRIPTION

3.1 Address Bus (A0-A15)

The sixteen bit Address Bus formed by A0-A15, address memory and I/O registers that exchange data on the Data Bus. The address lines can be set to the high impedance state by the Bus Enable (BE) signal.

3.2 Bus Enable (BE)

The Bus Enable (BE) input signal provides external control of the Address, Data and the RWB buffers. When Bus Enable is high, the Address, Data and RWB buffers are active. When BE is low, these buffers are set to the high impedance status. Bus Enable is an asynchronous signal.

3.3 Data Bus (D0-D7)

The eight Data Bus lines D0-D7 are used to provide instructions, data and addresses to the microprocessor and exchange data with memory and I/O registers. These lines may be set to the high impedance state by the Bus Enable (BE) signal.

3.4 Interrupt Request (IRQB)

The Interrupt Request (IRQB) input signal is used to request that an interrupt sequence be initiated. The program counter (PC) and Processor Status Register (P) are pushed onto the stack and the IRQB disable (I) flag is set to a "1" disabling further interrupts before jumping to the interrupt handler. These values are used to return the processor to its original state prior to the IRQB interrupt. The IRQB low level should be held until the interrupt handler clears the interrupt request source. When Return from Interrupt (RTI) is executed the (I) flag is restored and a new interrupt can be handled. If the (I) flag is cleared in an interrupt handler, nested interrupts can occur. The Wait-for-Interrupt (WAI) instruction may be used to reduce power and synchronize with, as an example timer interrupt requests.

3.5 Memory Lock (MLB)

The Memory Lock (MLB) output may be used to ensure the integrity of Read-Modify-Write instructions in a multiprocessor system. Memory Lock indicates the need to defer arbitration of the bus cycle when MLB is low. Memory Lock is low during the last three cycles of ASL, DEC, INC, LSR, ROL, ROR, TRB, and TSB memory referencing instructions.

3.6 Non-Maskable Interrupt (NMIB)

A negative transition on the Non-Maskable Interrupt (NMIB) input initiates an interrupt sequence after the current instruction is completed. Since NMIB is an edge-sensitive input, an interrupt will occur if there is a negative transition while servicing a previous interrupt. Also, after the edge interrupt occurs no further interrupts will occur if NMIB remains low. The NMIB signal going low causes the Program Counter (PC) and Processor Status Register information to be pushed onto the stack before jumping to the interrupt handler. These values are used to return the processor to its original state prior to the NMIB interrupt.



3.7 No Connect (NC)

The No Connect (NC) pins are not connected internally and should not be connected externally.

3.8 Phase 2 In (PHI2), Phase 2 Out (PHI2O) and Phase 1 Out (PHI1O)

Phase 2 In (PHI2) is the system clock input to the microprocessor internal clock. During the low power Standby Mode, PHI2 can be held in either high or low state to preserve the contents of internal registers since the microprocessor is a fully static design. The Phase 2 Out (PHI2O) signal is generated from PHI2. Phase 1 Out (PHI1O) is the inverted PHI2 signal. An external oscillator is recommended for driving PHI2 and used for the main system clock. All production test timing is based on PHI2. PHI2O and PHI1O were used in older systems for system timing and internal oscillators when an external crystal was used.

3.9 Read/Write (RWB)

The Read/Write (RWB) output signal is used to control data transfer. When in the high state, the microprocessor is reading data from memory or I/O. When in the low state, the Data Bus contains valid data to be written from the microprocessor and stored at the addressed memory or I/O location. The RWB signal is set to the high impedance state when Bus Enable (BE) is low.

3.10 Ready (RDY)

A low input logic level on the Ready (RDY) will halt the microprocessor in its current state. Returning RDY to the high state allows the microprocessor to continue operation following the next PHI2 negative transition. This bi-directional signal allows the user to single-cycle the microprocessor on all cycles including write cycles. A negative transition to the low state prior to the falling edge of PHI2 will halt the microprocessor with the output address lines reflecting the current address being fetched. This assumes the processor setup time is met. This condition will remain through a subsequent PHI2 in which the ready signal is low. This feature allows microprocessor interfacing with low-speed memory as well as direct memory access (DMA). The WAI instruction pulls RDY low signaling the WAit-for-Interrupt condition, thus RDY is a bi-directional pin. On the W65C02 hard core there is a WAIT output signal that can be used in ASIC's thus removing the bi-directional signal and RDY becomes only the input. In such a situation the WAI instruction will pull WAIT low and must be used external of the core to pull RDY low or the processor will continue as if the WAI never happened. The microprocessor will be released when RDY is high and a falling edge of PHI2 occurs. This again assumes the processor control setup time is met. The RDY pin has an active pull-up, when outputting a low level, the pull-up is disabled. The RDY pin can still be wire ORed.



3.11 Reset (RESB)

The Reset (RESB) input is used to initialize the microprocessor and start program execution. The RESB signal must be held low for at least two clock cycles after VDD reaches operating voltage. Ready (RDY) has no effect while RESB is being held low. All Registers are initialized by software except the Decimal and Interrupt disable mode select bits of the Processor Status Register (P) are initialized by hardware. When a positive edge is detected, there will be a reset sequence lasting seven clock cycles. The program counter is loaded with the reset vector from locations FFFC (low byte) and FFFD (high byte). This is the start location for program control. RESB should be held high after reset for normal operation.

Processor Status Register (P)

7	6	5	4	3	2	1	0
*	*	1	1	0	1	*	*
N	V		B	D	I	Z	C

*=software initialized

3.12 Set Overflow (SOB)

A negative transition on the Set Overflow (SOB) pin sets the overflow bit (V) in the status code register. The signal is sampled on the rising edge of PHI2. SOB was originally intended for fast input recognition because it can be tested with a branch instruction; however, it is not recommended in new system design and was seldom used in the past.

3.13 SYNChronize with OpCode fetch (SYNC)

The OpCode fetch cycle of the microprocessor instruction is indicated with SYNC high. The SYNC output is provided to identify those cycles during which the microprocessor is fetching an OpCode. The SYNC line goes high during the clock cycle of an OpCode fetch and stays high for the entire cycle. If the RDY line is pulled low during the clock cycle in which SYNC went high, the processor will stop in its current state and will remain in the state until the RDY line goes high. In this manner, the SYNC signal can be used to control RDY to cause single instruction execution.

3.14 Power (VDD) and Ground (VSS)

VDD is the positive power supply voltage and VSS is system logic ground.

3.15 Vector Pull (VPB)

The Vector Pull (VPB) output indicates that a vector location is being addressed during an interrupt sequence. VPB is low during the last interrupt sequence cycles, during which time the processor reads the interrupt vector. The VPB signal may be used to select and prioritize interrupts from several sources by modifying the vector addresses.



Table 3-1 Vector Locations

FFFE, F	BRK/IRQB	Software/Hardware
FFFC, D	RESB	Hardware
FFFA, B	NMIB	Hardware

Table 3-2 Pin Function Table

Pin	Description
A0-A15	Address Bus
BE	Bus Enable
D0-D7	Data Bus
IRQB	Interrupt Request
MLB	Memory Lock
NC	No Connection
NMIB	Non-Maskable Interrupt
PHI1O	Phase 1 Out Clock
PHI2	Phase 2 In Clock
PHI2O	Phase 2 Out Clock
RDY	Ready
RESB	Reset
RWB	Read/Write
SOB	Set Overflow
SYNC	Synchronize
VDD	Positive Power Supply
VPB	Vector Pull
VSS	Internal Logic Ground

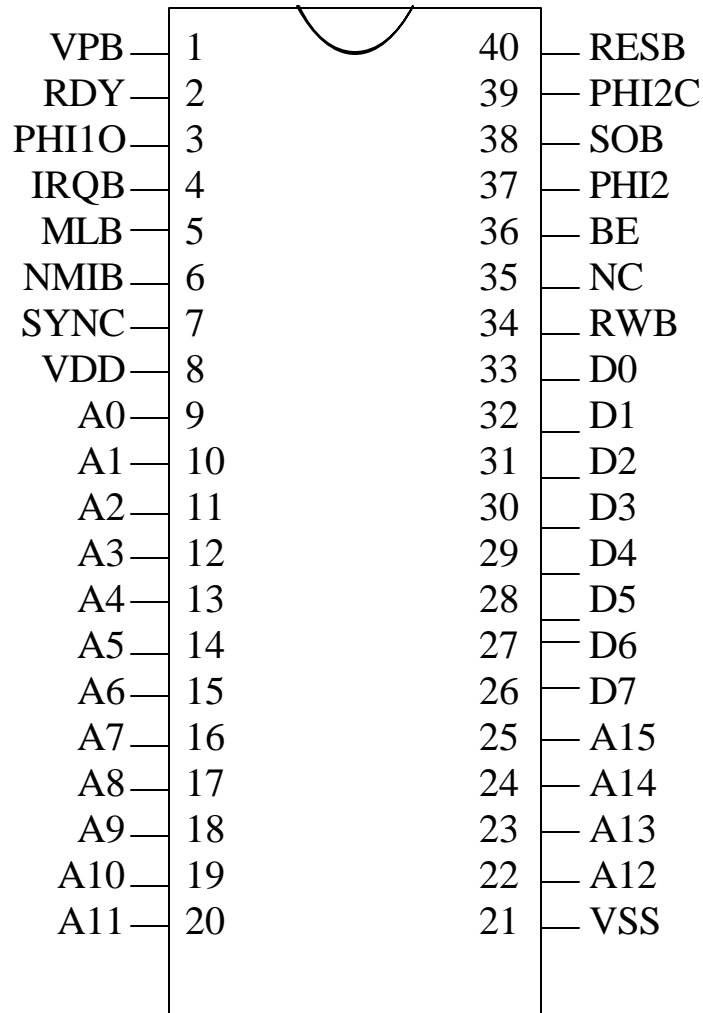

Figure 3-1 W65C02S 40 Pin PDIP Pinout

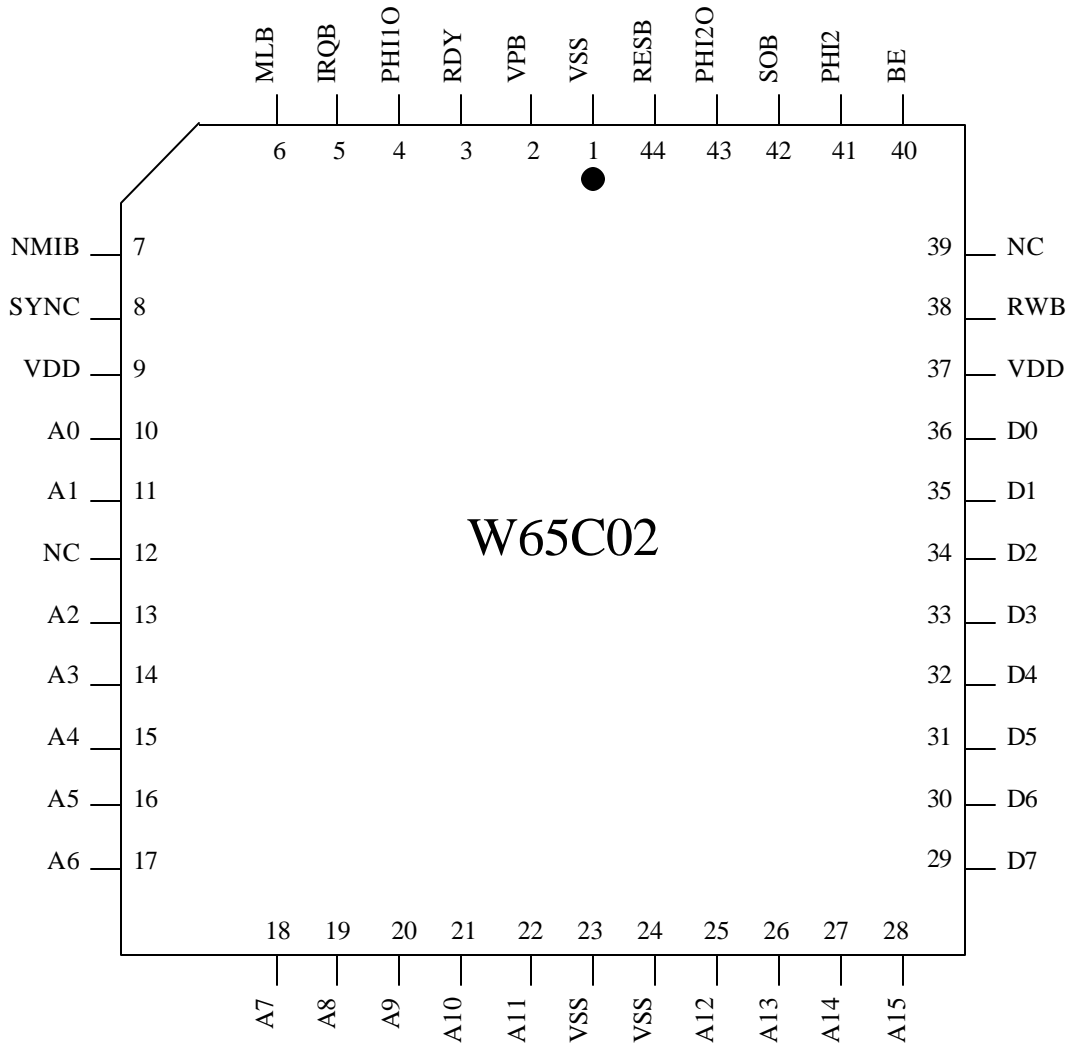

Figure 3-2 W65C02S 44 Pin PLCC Pinout

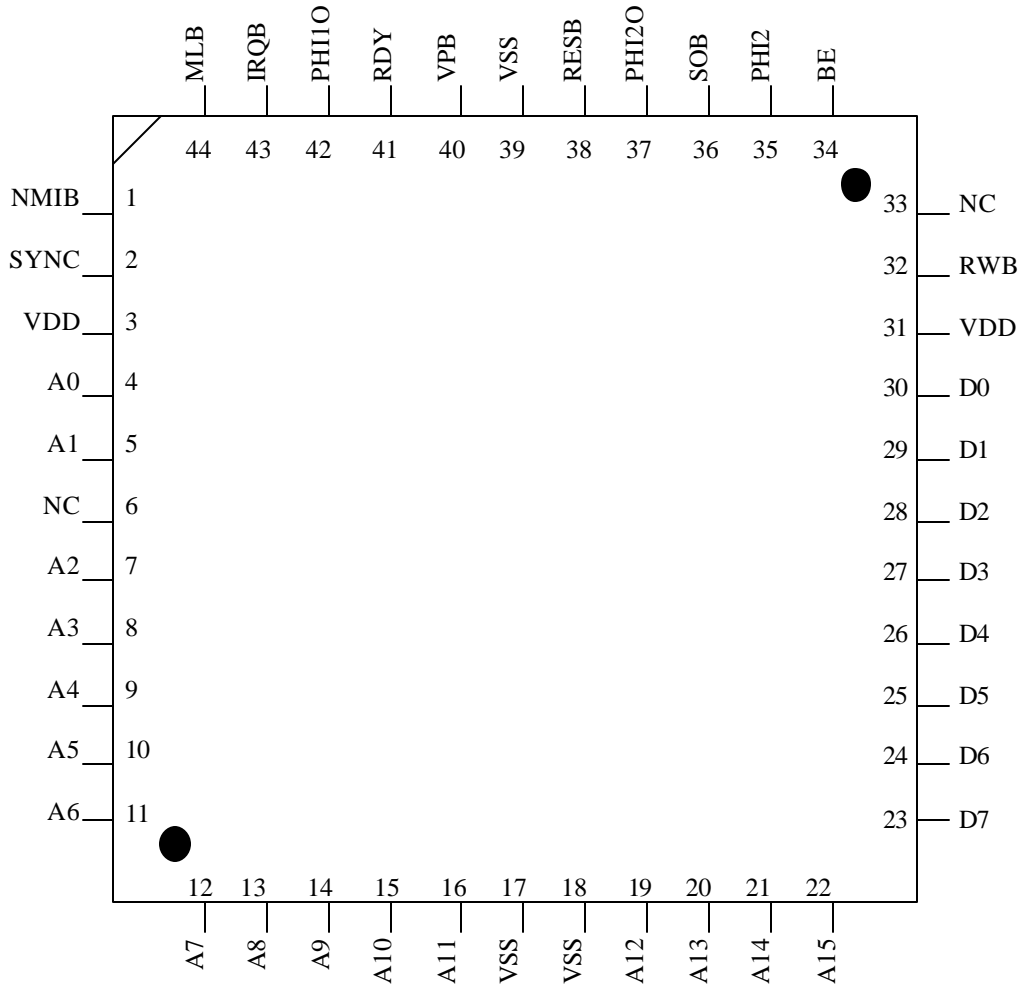

Figure 3-3 W65C02S 44 Pin QFP Pinout



4 ADDRESSING MODES

The W65C02S is capable of directly addressing 65,536 bytes of memory. The Program Address and Data Address space is contiguous throughout the 65,536 byte address space. Words, arrays, records, or any data structures may span the 65,536 byte address space. The following addressing mode descriptions provide additional detail as to how effective addresses are calculated. Sixteen addressing modes are available for the W65C02S. This address space has special significance within certain addressing modes.

4.1 Absolute a

With Absolute addressing the second and third bytes of the instruction form the 16-bit address.

Byte:	2	1	0
Instruction:	ADH	ADL	OpCode
Operand Address:	ADH ADL		

4.2 Absolute Indexed Indirect (a,x)

With the Absolute Indexed Indirect addressing mode, the X Index Register is added to the second and third bytes of the instruction to form an address to a pointer. This address mode is only used with the JMP instruction and the program Counter is loaded with the first and second bytes at this pointer.

Byte:	2	1	0
Instruction:	ADH	ADL	OpCode
Indirect Base address:	ADH ADL		
	+	X	
Indirect address:	effective address		
New PC value:	indirect address		

4.3 Absolute Indexed with X a,x

With the Absolute Indexed with X addressing mode, the X Index Register is added to the second and third bytes of the instruction to form the 16-bits of the effective address.

Byte:	2	1	0
Instruction:	ADH	ADL	OpCode
Operand address:	ADH ADL		
	+	X	
	effective address		



4.4 Absolute Indexed with Y a, y

With the Absolute Indexed with Y addressing mode, the Y Index Register is added to the second and third bytes of the instruction to form the 16-bit effective address.

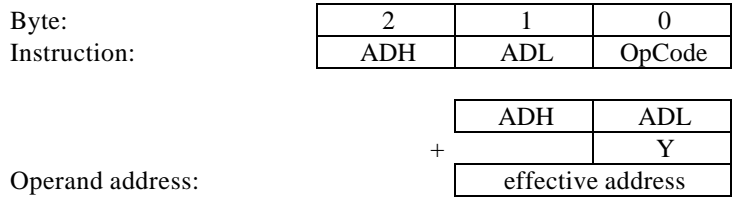

Operand address:

4.5 Absolute Indirect (a)

With the Absolute Indirect addressing mode, the second and third bytes of the instruction form an address to a pointer. This address mode is only used with the JMP instruction and the Program Counter is loaded with the first and second bytes at this pointer.

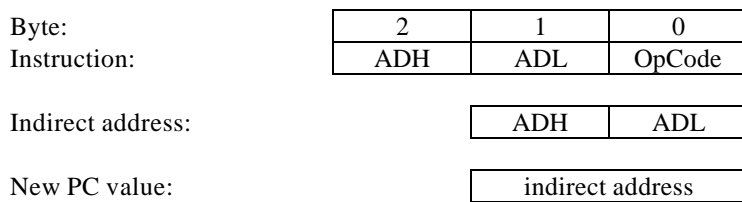

4.6 Accumulator A

With Accumulator addressing the operand is implied as the Accumulator and therefore only a single byte forms the instruction..

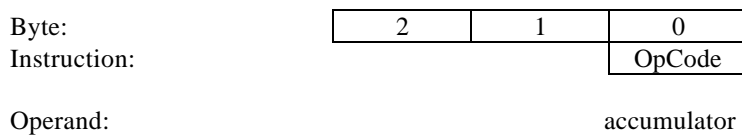

4.7 Immediate Addressing

With Immediate Addressing the operand is the second byte of the instruction.

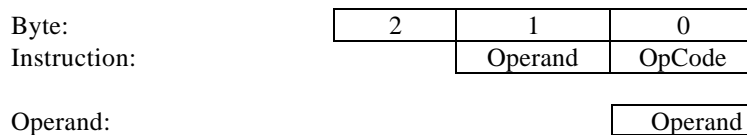

4.8 Implied i

Implied addressing uses a single byte instruction. The operand is implicitly defined by the instruction.

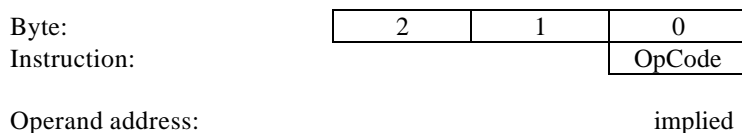



4.9 Program Counter Relative r

The Program Counter relative addressing mode, sometimes referred to as Relative Addressing, is used with the Branch instructions. If the condition being tested is met, the second byte of the instruction is added to the Program Counter and program control is transferred to this new memory location.

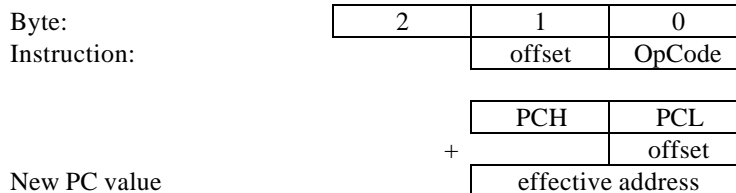

4.10 Stack s

The Stack may use memory from 0100 to 01FF and the effective address of the Stack address mode will always be within this range. Stack addressing refers to all instructions that push or pull data from the stack, such as Push, Pull, Jump to Subroutine, Return from Subroutine, Interrupts and Return from Interrupt.

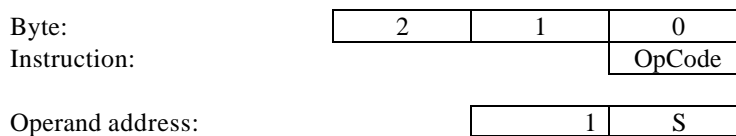

4.11 Zero Page zp

With Zero Page (zp) addressing the second byte of the instruction is the address of the operand in page zero.

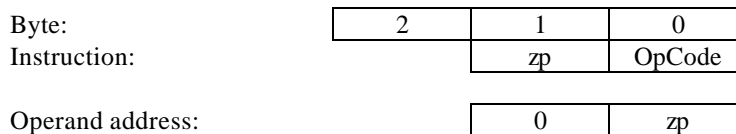

4.12 Zero Page Indexed Indirect (zp,x)

The Zero Page Indexed Indirect addressing mode is often referred to as Indirect,X. The second byte of the instruction is the zero page address to which the X Index Register is added and the result points to the low byte of the indirect address.

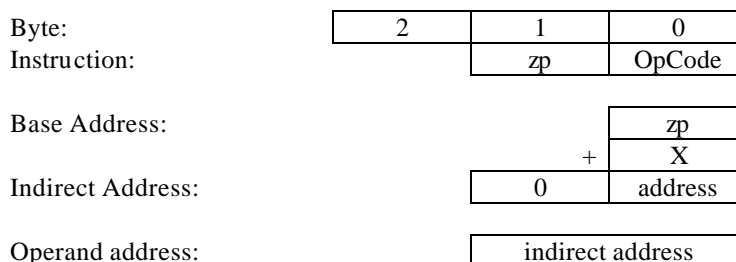



4.13 Zero Page Indexed with X zp,x

With Zero Page Indexed with X addressing mode, the X Index Register is added to the second byte of instruction to form the effective address.

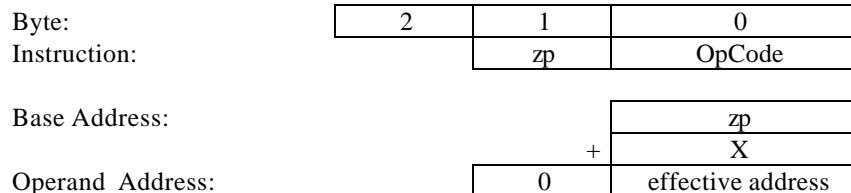

4.14 Zero Page Indexed with Y zp, y

With Zero Page Indexed with Y addressing, the second byte of the instruction is the zero page address to which the Y Index Register is added to form the page zero effective address.

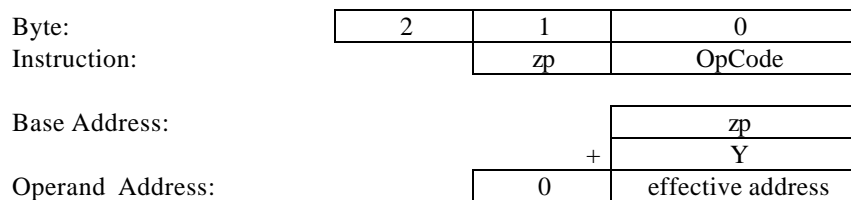

4.15 Zero Page Indirect (zp)

With Zero Page Indirect addressing mode, the second byte of the instruction is a zero page indirect address that points to the low byte of a two byte effective address.

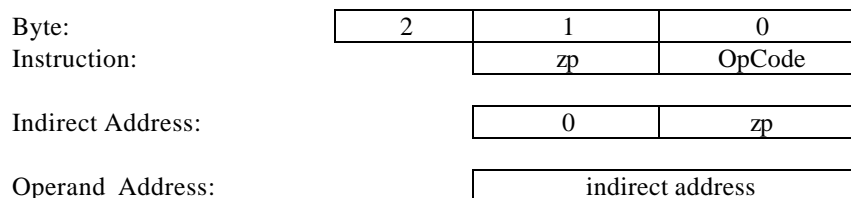

4.16 Zero Page Indirect Indexed with Y (zp), y

The Zero Page Indirect Indexed with Y addressing mode is often referred to as Indirect Y. The second byte of the instruction points to the low byte of a two byte (16-bit) base address in page zero. Y Index Register is added to the base address to form the effective address.

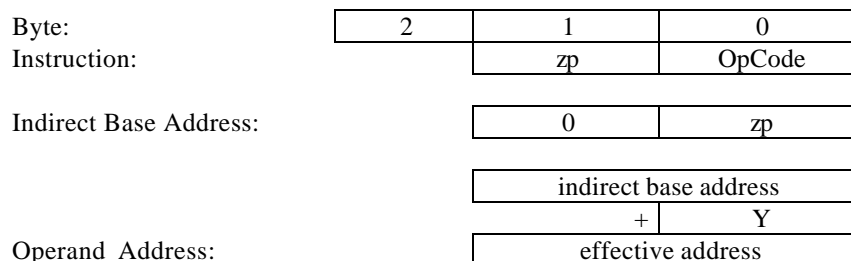



Table 4-1 Addressing Mode Table

Address Mode	Instruction Times in Memory Cycle		Memory Utilization in Number of Program Sequence Bytes	
	Original NMOS 6502	W65C02S	Original NMOS 6502	W65C02S
1. Absolute a	4 (3)	4 (3)	3	3
2. Absolute Indexed Indirect (a,x)	5	5	3	3
3. Absolute Indexed with X a,x	4 (1,3)	4 (1,3)	3	3
4. Absolute Indexed with Y a,y	4 (1)	4 (1)	3	3
5. Absolute Indirect (a)	4 (3)	4 (3)	3	3
6. Accumulator A	2	2	1	1
7. Immediate #	2	2	2	2
8. Implied i	2	2	1	1
9. Program Counter Relative r	2 (2)	2 (2)	2	2
10. Stack s	3-7	3-7	1-3	1-4
11. Zero Page zp	3 (3)	3 (3)	2	2
12. Zero Page Indexed Indirect (zp,x)	6	6	2	2
13. Zero Page Indexed with X zp,x	4 (3)	4 (3)	2	2
14. Zero Page Indexed with Y zp,y	4	4	2	2
15. Zero Page Indirect (zp)	-	5	-	2
16. Zero Page Indirect Indexed with Y (zp),y	5	5	2	2

Notes: (indicated in parenthesis)

1. Page boundary, add 1 cycle if page boundary is crossed when forming address
2. Branch taken, add 1 cycle if branch is taken
3. Read-Modify-Write, add 2 cycles



5 OPERATION TABLES

Table 5-1 Instruction Set Table

1.	ADC	ADd memory to accumulator with Carry
2.	AND	"AND" memory with accumulator
3.	ASL	Arithmetic Shift one bit Left, memory or accumulator
4.	•BBR	Branch on Bit Reset
5.	•BBS	Branch of Bit Set
6.	BCC	Branch on Carry Clear (Pc=0)
7.	BCS	Branch on Carry Set (Pc=1)
8.	BEQ	Branch if EQual (Pz=1)
9.	BIT	Bit Test
10.	BMI	Branch if result MINus (Pn=1)
11.	BNE	Branch if Not Equal (Pz=0)
12.	BPL	Branch if result PLus (Pn=0)
13.	•BRA	BRanch Always
14.	BRK	BReaK instruction
15.	BVC	Branch on oVerflow Clear (Pv=0)
16.	BVS	Branch on oVerflow Set (Pv=1)
17.	CLC	CLear Cary flag
18.	CLD	CLear Decimal mode
19.	CLI	CLear Interrupt disable bit
20.	CLV	CLear oVerflow flag
21.	CMP	CoMPare memory and accumulator
22.	CPX	ComPare memory and X register
23.	CPY	ComPare memory and Y register
24.	DEC	DECrement memory or accumulate by one
25.	DEX	DEcrement X by one
26.	DEY	DEcrement Y by one
27.	EOR	"Exclusive OR" memory with accumulate
28.	INC	INCrement memory or accumulate by one
29.	INX	INcrement X register by one
30.	INY	INcrement Y register by one
31.	JMP	JuMP to new location
32.	JSR	Jump to new location Saving Return (Jump to SubRoutine)
33.	LDA	LoaD Accumulator with memory
34.	LDX	LoaD the X register with memory
35.	LDY	LoaD the Y register with memory
36.	LSR	Logical Shift one bit Right memory or accumulator
37.	NOP	No OPeration
38.	ORA	"OR" memory with Accumulator
39.	PHA	PusH Accumulator on stack
40.	PHP	PusH Processor status on stack
41.	PHX	PusH X register on stack
42.	PHY	PusH Y register on stack
43.	PLA	PuLl Accumulator from stack
44.	PLP	PuLl Processor status from stack
45.	•PLX	PuLl X register from stack
46.	•PLY	PuLl Y register from stack
47.	•RMB	Reset Memory Bit
48.	ROL	ROtate one bit Left memory or accumulator
49.	ROR	ROtate one bit Right memory or accumulator
50.	RTI	ReTurn from Interrupt
51.	RTS	ReTurn from Subroutine
52.	SBC	SuBtract memory from accumulator with borrow (Carry bit)

53.	SED	SEt Decimal mode
54.	SEI	SEt Interrupt disable status
55.	•SMB	Set Memory Bit
56.	STA	STore Accumulator in memory
57.	•STP	SToP mode
58.	STX	STore the X register in memory
59.	STY	STore the Y register in memory
60.	•STZ	STore Zero in memory
61.	TAX	Transfer the Accumulator to the X register
62.	TAY	Transfer the Accumulator to the Y register
63.	•TRB	Test and Reset memory Bit
64.	•TSB	Test and Set memory Bit
65.	TSX	Transfer the Stack pointer to the X register
66.	TXA	Transfer the X register to the Accumulator
67.	TXS	Transfer the X register to the Stack pointer register
68.	TYA	Transfer Y register to the Accumulator
69.	•WAI	WAit for Interrupt

Note: •=New Instruction



Table 5-2 W65C02S OpCode Matrix

W65C02S OpCode Matrix										M S D						
M S D	0	1	2	3	4	5	6	7	8	9	A	B	C	D	E	F
0	BRK s 7.1	ORA (zp,x) 6.2			TSB zp 5.2	ORA zp 3.2	ASL zp 5.2	RMB0 zp 5.2	PHP s 3.1	ORA # 2.2	ASL A 2.1		TSB a 6.3	ORA a 4.3	ASL a 6.3	BBR0 r 5.3
1	BPL r 2.2	ORA (zp,y) 5.2	ORA (zp) 5.2 *		TRB zp 5.2	ORA zp,x 4.2	ASL zp,x 6.2	RMB1 zp 5.2	CLC i 2.1	ORA ay 4.3	INC A 2.1 *		TRB a 6.3	ORA a,x 4.3	ASL a,x 6.3	BBR1 r 5.3
2	JSR a 6.3	AND (zp,x) 6.2			BIT zp 3.2	AND zp 3.2	ROL zp 5.2	RMB2 zp 5.2	PLP s 4.1	AND # 2.2	ROL A 2.1		BIT a 4.3	AND a 4.3	ROL a 6.3	BBR2 r 5.3
3	BMI r 2.2	AND (zp,y) 5.2 *	AND (zp) 5.2 *		BIT zp,x 4.2	AND zp,x 4.2	ROL zp,x 6.2	RMB3 zp 5.2	SEC i 2.1	AND ay 4.3	DEC A 2.1 *		BIT a,x 4.3 *	AND a,x 4.3	ROL a,x 6.3	BBR3 r 5.3
4	RTI s 6.1	EOR (zp,x) 6.2				EOR zp 3.2	LSR zp 5.2	RMB4 zp 5.2	PHA s 3.1	EOR # 2.2	LSR A 2.1		JMP a 3.3	EOR a 4.3	LSR a 6.3	BBR4 r 5.3
5	BVC r 2.2	EOR (zp,y) 5.2	EOR (zp) 5.2 *			EOR zp,x 4.2	LSR zp,x 6.2	RMB5 zp 5.2	CLI i 2.1	EOR ay 4.3	PHY s 3.1			EOR a,x 4.3	LSR a,x 6.3	BBR5 r 5.3
6	RTS s 6.1	ADC (zp,x) 6.2			STZ zp 3.2	ADC zp 3.2	ROR zp 5.2	RMB6 zp 5.2	PLA s 4.1	ADC # 2.2	ROR A 2.1		JMP (a) 6.3	ADC a 4.3	ROR a 6.3	BBR6 r 5.3
7	BVS r 2.2	ADC (zp,y) 5.2	ADC (zp) 5.2 *		STZ zp,x 4.2	ADC zp,x 4.2	ROR zp,x 6.2	RMB7 zp 5.2	SEI i 2.1	ADC ay 4.3	PLY s 4.1		JMP (ax) 6.3 *	ADC a,x 4.3	ROR a,x 6.3	BBR7 r 5.3
8	BRA r 3.2	STA (zp,x) 6.2			STY zp 3.2	STA zp 3.2	STX zp 3.2	SMB0 zp 5.2	DEY i 2.1	BIT # 2.2	TXA i 2.1		STY a 4.3	STA a 4.3	STX a 4.3	BBS0 r 5.3
9	BCC r 2.2	STA (zp,y) 6.2	STA (zp) 5.2 *		STY zp,x 4.2	STA zp,x 4.2	STX zp,y 4.2	SMB1 zp 5.2	TYA i 2.1	STA ay 5.3	TXS i 2.1		STZ a 4.3	STA a,x 4.3	STZ a,x 5.3	BBS1 r 5.3
A	LDY # 2.2	LDA (zp,x) 6.2	LDX # 2.2		LDY zp 3.2	LDA zp 3.2	LDX zp 3.2	SMB2 zp 5.2	TAY i 2.1	LDA # 2.2	TAX i 2.1		LDY a 4.3	LDA a 4.3	LDX a 4.3	BBS2 r 5.3
B	BCS r 2.2	LDA (zp,y) 5.2	LDA (zp) 5.2 *		LDY zp,x 4.2	LDA zp,x 4.2	LDX zp,y 4.2	SMB3 zp 5.2	CLV i 2.1	LDA ay 4.3	TSX i 2.1		LDY a,x 4.3	LDA a,x 4.3	LDX a,y 4.3	BBS3 r 5.3
C	CPY # 2.2	CMP (zp,x) 6.2			CPY zp 3.2	CMP zp 3.2	DEC zp 5.2	SMB4 zp 5.2	INY i 2.1	CMP # 2.2	DEX i 2.1	WAI i 3.1	CPY a 4.3	CMP a 4.3	DEC a 6.3	BBS4 r 5.3
D	BNE r 2.2	CMP (zp,y) 5.2	CMP (zp) 5.2 *			CMP zp,x 4.2	DEC zp,x 6.2	SMB5 zp 5.2	CLD i 2.1	CMP ay 4.3	PHX s 3.1	STP i 3.1		CMP a,x 4.3	DEC a,x 6.3	BBS5 r 5.3
E	CPX # 2.2	SBC (zp,x) 6.2			CPX zp 3.2	SBC zp 3.2	INC zp 5.2	SMB6 zp 5.2	INX i 2.1	SBC # 2.2	NOP i 2.1		CPX a 4.3	SBC a 4.3	INC a 6.3	BBS6 r 5.3
F	BEQ r 2.2	SBC (zp,y) 5.2	SBC (zp) 5.2 *			SBC zp,x 4.2	INC zp,x 6.2	SMB7 zp 5.2	SED i 2.1	SBC ay 4.3	PLX s 4.1			SBC a,x 4.3	INC a,x 6.3	BBS7 r 5.3
	0	1	2	3	4	5	6	7	8	9	A	B	C	D	E	F

* = Old instruction with new addressing modes

● = New Instruction



6 DC, AC AND TIMING CHARACTERISTICS

Table 6-1 Absolute Maximum Ratings

Rating	Symbol	Value
Supply Voltage	VDD	-0.3 to +7.0V
Input Voltage	VIN	-0.3 to VDD +0.3V
Storage Temperature	TS	-55° C to +150° C

This device contains input protection against damage due to high static voltages or electric fields; however, precautions should be taken to avoid application of voltages higher than the maximum rating.

Note: Exceeding these ratings may result in permanent damage. Functional operation under these conditions is not implied.



6.1 DC Characteristics TA = -40°C to +85°C (PLCC, QFP) TA= 0°C to 70°C (DIP)

Table 6-2 DC Characteristics

Symbol		5.0 +/- 5%		3.3 +/- 10%		3.0 +/- 5%		2.5 +/- 5%		1.8 +/- 5%		Units
		Min	Max	Min	Max	Min	Max	Min	Max	Min	Max	
VDD	Supply Voltage	4.75	5.25	3.0	3.6	2.85	3.15	2.37	2.63	1.71	1.89	V
Vih	Input High Voltage (1) BE, D0-D7, RDY, SOB IRQB, NMIB, PHI2, RESB	VDDx0.7 VDD-0.4	VDD+0.3 VDD+0.3	VDDx0.7 VDD-0.4	VDD+0.3 VDD+0.3	VDDx0.7 VDD-0.4	VDD+0.3 VDD+0.3	VDDx0.7 VDD-0.4	VDD+0.3 VDD+0.3	VDDx0.7 VDD-0.4	VDD+0.3 VDD+0.3	V
Vil	Input Low Voltage (1) BE, D0-D7, RDY, SOB, IRQB, NMIB, PHI2, RESB	VSS-0.3 VSS-0.3	VDDx0.3 VSS+0.4	VSS-0.3 VSS-0.3	VDDx0.3 VSS+0.4	VSS-0.3 VSS-0.3	VDDx0.3 VSS+0.4	VSS-0.3 VSS-0.3	VDDx0.3 VSS+0.4	VSS-0.3 VSS-0.3	VDDx0.3 VSS+0.1	V
Iin	Input Leakage Current (Vin=0.4 to 2.4, VDD=max) BE, IRQB, NMIB, PHI2, RESB, SOB	-20	20	-20	20	-20	20	-20	20	-20	20	nA
I _{pup}	RDY Input Pull-UP Current (Vin=VDD-0.4V (min) Vin=0.4(max))	-1	-20	-1	-20	-1	-10	-1	-10	-0.25	-2.0	μA
Iin	D0-D7 (off state)	-20	20	-20	20	-20	20	-20	20	-20	20	nA
Ioh	Output High current (Voh=VDD-.4, VDD=min) A0-A15, D0-D7, MLB, PHI10, PHI20, RWB, SYNC, VPB	700	-	350	-	300	-	200	-	100	-	uA
Iol	Output Low current (Vol=0.4, VDD=min) A0-A15, D0-D7, MLB, PHI10, PHI20, RWB, SYNC, VPB	1.6	-	1.6	-	1.6	-	1.0	-	0.5	-	mA
I _{dd}	Supply Current (with Tester Loading) Supply Current (Core)	-	1.5 0.5	-	1.0 0.3	-	1.0 0.25	-	0.75 0.2	-	0.5 0.15	mA/ MHz
I _{by}	Standby Current Outputs Unloaded BE, IRQB, NMIB, PHI2, SOB=VDD	-	1	-	1	-	1	-	1	-	1	uA
Cin Cts	*Capacitance (Vin=0V, TA=25°C, f=1MHz) BE, IRQB, NMIB, PHI2, RESB, RDY, SOB A0-A15, D0-D7, RWB <small>*Not inspected during production test; verified on a sample basis.</small>	-	5	-	5	-	5	-	5	-	5	pF

(1) For high speed tests, Vih and Vil are set for VDD-.2v and VSS+.2V. The input "1" and "0" thresholds are tested at 1 MHz.

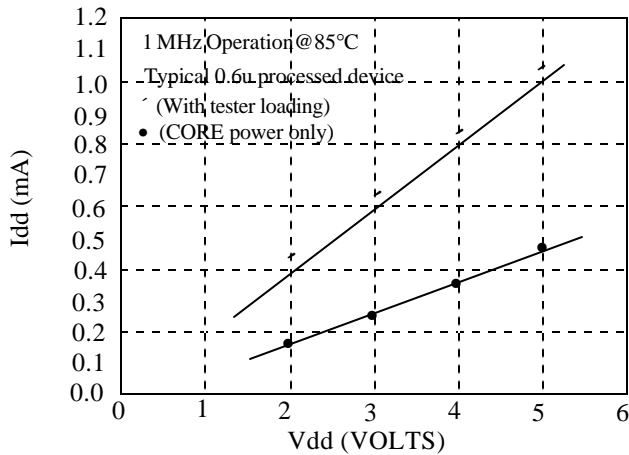

Figure 6-1 I_{dd} vs V_{dd}

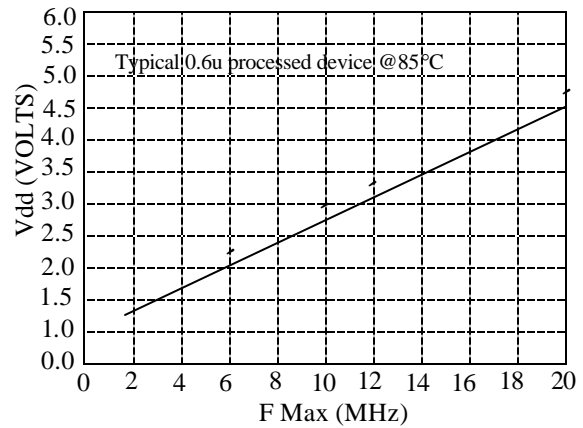

Figure 6-2 F Max vs V_{dd}



6.2 AC Characteristics TA = -40°C to +85°C (PLCC, QFP) TA= 0°C to 70°C (DIP)

Table 6-3 AC Characteristics

Symbol	Parameter	5.0 +/-5%		3.3 +/-10%		3.0 +/-5%		2.5 +/-5%		1.8 +/-5%		Units
		14MHz		8MHz		8MHz		4MHz		2MHz		
		Min	Max	Min	Max	Min	Max	Min	Max	Min	Max	
VDD	Supply Voltage	4.75	5.25	3.0	3.6	2.85	3.15	2.375	2.675	1.71	1.89	V
tACC	Access Time	30	-	70	-	70	-	145	-	290	-	nS
tAH	Address Hold Time	10	-	10	-	10	-	10	-	10	-	nS
tADS	Address Setup Time	-	30	-	40	-	40	-	75	-	150	nS
tBVD	BE to Valid Data (1)	-	25	-	30	-	30	-	30	-	30	nS
CEXT	Capacitive Load (2)	-	35	-	35	-	35	-	35	-	35	pF
tPWH	Clock Pulse Width High	35	-	62	-	62	-	125	-	250	-	nS
tPWL	Clock Pulse Width Low	35	-	63	-	63	-	125	-	250	-	nS
tCYC	Cycle Time (3)	70	-	125	-	125	-	250	-	500	-	nS
tF,tR	Fall Time, Rise Time	-	5	-	5	-	5	-	5	-	5	nS
tPCH	Processor Control Hold Time	10	-	10	-	10	-	10	-	10	-	nS
tPCS	Processor Control Setup Time	10	-	15	-	15	-	30	-	60	-	nS
tDHR	Read Data Hold Time	10	-	10	-	10	-	10	-	10	-	nS
tDSR	Read Data Setup Time	10	-	15	-	15	-	30	-	60	-	nS
tMDS	Write Data Delay Time	-	25	-	40	-	40	-	70	-	140	nS
tDHW	Write Data Hold Time	10	-	10	-	10	-	10	-	10	-	nS

1. BE to High Impedance State is not testable but should be the same amount of time as BE to Valid Data
2. ATE or loading on all outputs
3. Since this is a static design, the maximum cycle time could be infinite.

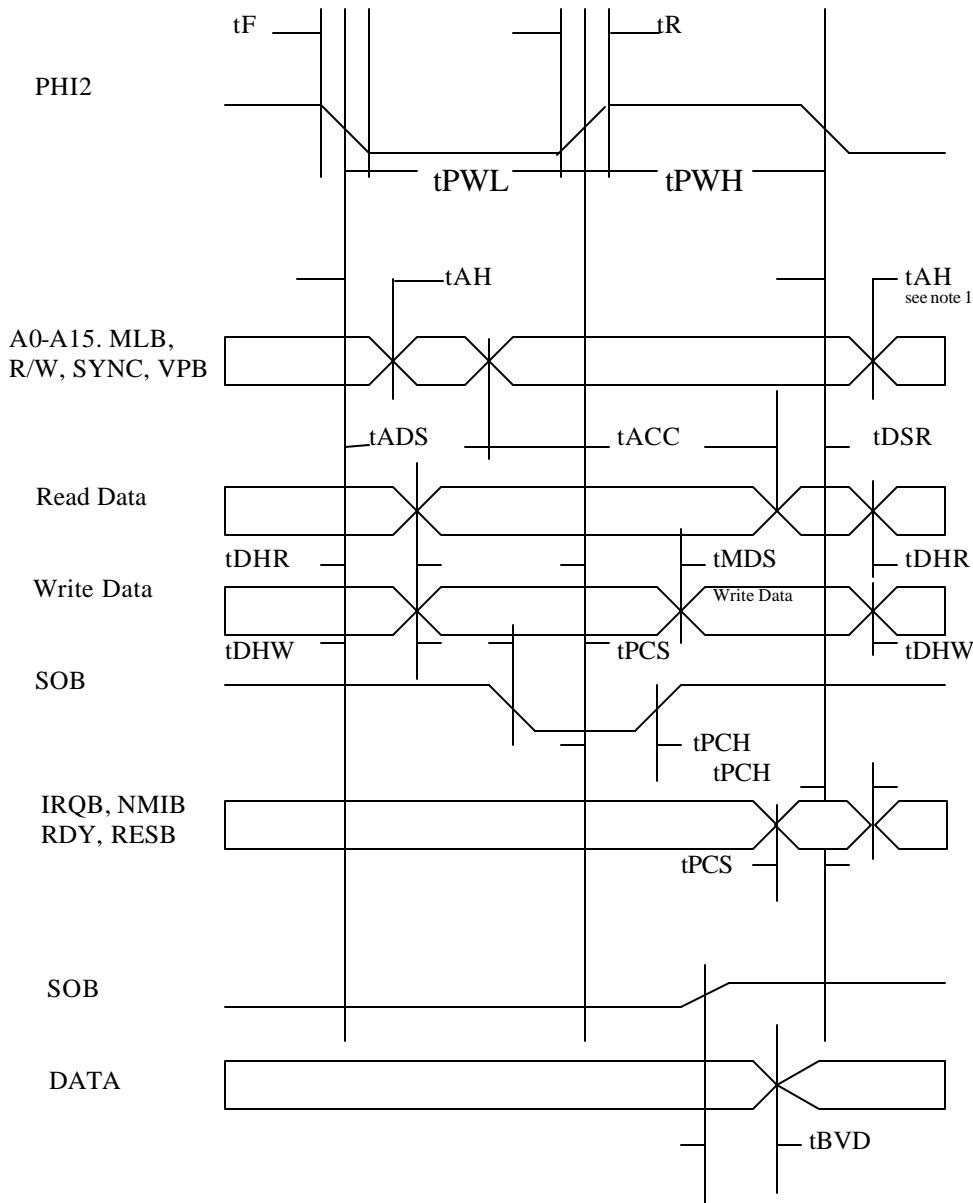

Figure 6-3 General Timing Diagram

Timing Notes:

1. Timing measurement points are 50% VDD.
2. PHI10 and PHI20 clock delay from PHI2 is no longer specified or tested and WDC recommends using an oscillator for system time base and PHI2 processor input clock.



The page left blank intentionally



Table 6-4 Operation, Operation Codes and Status Register

Mnemonic	Operation # Immediate Data ~ NOT ^ AND v OR ⊕ Exclusive OR	a	(a,x)	a,x	a,y	(a)	A	#	i	r	s	zp	(zp,x)	zp,x	zp,y	(zp)	(zp),y	Processor Status Register (P) *User Defined								
		1	2	3	4	5	6	7	8	9	10	11	12	13	14	15	16	7	6	5	4	3	2	1	0	
		N	V	I	D	Z	C												N	V	I	D	Z	C		
ADC	A+M+C→A	6D		7D	79			69				65	61	75		72	71	N	V	.	.	.	Z	C		
AND	A^M→A	2D		3D	39			29				25	21	35		32	31	N	Z	.		
ASL	C← 7 6 5 4 3 2 1 0 ←0	0E		1E			0A					06		16				N	Z	C		
BBR0	Branch on bit 0 reset									0F							
BBR1	Branch on bit 1 reset									1F							
BBR2	Branch on bit 2 reset									2F							
BBR3	Branch on bit 3 reset									3F							
BBR4	Branch on bit 4 reset									4F							
BBR5	Branch on bit 5 reset									5F							
BBR6	Branch on bit 6 reset									6F							
BBR7	Branch on bit 7 reset									7F							
BBS0	Branch on bit 0 set									8F							
BBS1	Branch on bit 1 set									9F							
BBS2	Branch on bit 2 set									AF							
BBS3	Branch on bit 3 set									BF							
BBS4	Branch on bit 4 set									CF							
BBS5	Branch on bit 5 set									DF							
BBS6	Branch on bit 6 set									EF							
BBS7	Branch on bit 7 set									FF							
BCC	Branch C = 0									90							
BCS	Branch if C = 1									B0							
BEQ	Branch if Z = 1									F0							
BIT	A ^ M	2C		3C				89				24		34				M ₇	M ₆	.	.	.	Z	.	.	
BMI	Branch if N = 0									30							
BNE	Branch if Z = 0									D0							
BPL	Branch if N = 0									10							
BRA	Branch Always									80							



Table 6-5 Instruction Timing Chart

Address Mode	Note	Cycle	VPB	MLB	SYNC	Address Bus	Data Bus	RWB
1a. Absolute a ADC, AND, BIT, CMP, CPX, CPY, EOR, LDA, LDX, LDY, ORA, SBC, STA, STX, STY, STZ 16 OpCodes, 3 bytes, 4&5 cycles	(6)	1	1	1	1	PC	OpCode	1
		2	1	1	0	PC+1	AAL	1
		3	1	1	0	PC+2	AAH	1
		4	1	1	0	AA	Data	1/0
1b. Absolute (R-M-W) a ASL, DEC, INC, LSR, ROL, ROR, TRB, TSB 8 OpCodes, 3 bytes, 6 cycles		1	1	1	1	PC	OpCode	1
		2	1	1	0	PC+1	AAL	1
		3	1	1	0	PC+2	AAH	1
		4	1	0	0	AA	Data	1
		5	1	0	0	AA	IO	1
		6	1	0	0	AA	Data	0
1c. Absolute (JUMP) a JMP (4C) 1 OpCode, 3 bytes, 3 cycles		1	1	1	1	PC	OpCode	1
		2	1	1	0	PC+1	New PCL	1
		3	1	1	0	PC+2	New PCH	1
		1	1	1	1	New PC	New OpCode	1
1d. Absolute (JUMP to subroutine) a JSR (20) 1 OpCode, 3 bytes, 3 cycles (different order from N6502)		1	1	1	1	PC	OpCode	1
		2	1	1	0	PC+1	New PCL	1
		3	1	1	0	S	IO	1
		4	1	1	0	S	PCH	0
		5	1	1	0	S+1	PCL	0
		6	1	1	0	PC+2	New PCH	1
		1	1	1	1	New PC	New OpCode	1
2. Absolute Indexed Indirect (a, x) JMP (7C) 1 OpCode, 3 bytes, 6 cycles	(1)	1	1	1	1	PC	OpCode	1
		2	1	1	0	PC+1	AAL	1
		3	1	1	0	PC+2	AAH	1
		4	1	1	0	PC+2	IO	1
		5	1	1	0	AA+X	New PCL	1
		6	1	1	0	AA+X+1	New PCH	1
		1	1	1	1	New PC	OpCode	1
3a. Absolute , X a, x ADC, AND, BIT, CMP, EOR, LDA, LDY, ORA, SBC, STA, STZ 11 OpCodes, 3 bytes, 4,5 and 6 cycles	(1) (6)	1	1	1	1	PC	OpCode	1
		2	1	1	0	PC+1	AAL	1
		3	1	1	0	PC+2	AAH	1
		4	1	1	0	AA+X	Data	1/0
3b. Absolute, X(R-M-W) a, x ASL, DEC, INC, LSR, ROL, ROR 6 OpCodes, 3 bytes, 7 cycles	(1)	1	1	1	1	PC	OpCode	1
		2	1	1	0	PC+1	AAL	1
		3	1	1	0	PC+2	AAH	1
		4	1	1	0	AAH, AAL+X	IO	1
		5	1	0	0	AA+X	Data	1
		6	1	0	0	AA+X+1	IO	1
		7	1	0	0	AA+X	Data	0
4. Absolute, Y a, y ADC, AND, CMP, EOR, LDA, LDX, ORA, SBC, STA 9 OpCodes, 3 bytes, 4,5 and 6 cycles	(1) (6)	1	1	1	1	PC	OpCode	1
		2	1	1	0	PC+1	AAL	1
		3	1	1	0	PC+2	AAH	1
		4	1	1	0	AA+Y	Data	1/0
5. Absolute Indirect (a) JMP (6C) 1 OpCode, 3 bytes, 6 cycles		1	1	1	1	PC	OpCode	1
		2	1	1	0	PC+1	AAL	1
		3	1	1	0	PC+2	AAH	1
		4	1	1	0	PC+2	IO	1
		5	1	1	0	0,AA	New PCL	1
		6	1	1	0	0,AA+1	New PCH	1
		1	1	1	1	New PC	OpCode	1
6. Accumulator A ASL, DEC, INC, LSR, ROL, ROR 6 OpCodes, 1 byte, 2 cycles		1	1	1	1	PC	OpCode	1
		2	1	1	0	PC+1	IO	1
7. Immediate # ADC, AND, BIT, CLR, CMP, CPY, CPX, EOR, LDA, LDX, LDY, ORA, SBC 13 OpCodes, 2 bytes, 2 and 5 cycles	(6)	1	1	1	1	PC	OpCode	1
		2	1	1	0	PC+1	ID	1
8a. Implied i CLC, CLD, CLI, CLV, DEX, DEY, INX, INY, NOP, SEC, SED, SEI, TAX, TAY, TXA, TSX, TXS, TYA 18 OpCodes, 1 byte, 2 cycles		1	1	1	1	PC	OpCode	1
		2	1	1	0	PC+1	IO	1



Address Mode	Note	Cycle	VPB	MLB	SYNC	Address Bus	Data Bus	RWB
8b. Stop the Clock i STP 1 OpCode, 1 byte, 3 cycles		1	1	1	1	PC	OpCode	1
		2	1	1	0	PC+1	IO	1
		3	1	1	0	PC+1	IO	1
	RESB=1	1c	1	1	0	PC+1	RES(BRK)	1
	RESB=0	1b	1	1	0	PC+1	RES(BRK)	1
	RESB=0	1a	1	1	0	PC+1	RES(BRK)	1
		1	1	1	1	PC+1	BEGIN	1
8c. Wait for Interrupt i WAI 1 OpCode, 1 byte, 3 cycles		1	1	1	1	PC	OpCode	1
	(4)	2	1	1	0	PC+1	IO	1
		3	1	1	0	PC+1	IO	1
	IRQB NMIB	1	1	1	1	PC+1	IRQ(BRK)	1
9a. Relative r BCC, BCS, BEQ, BMI, BNE, BPL, BRA, BVC, BVS 9 OpCodes, 2 bytes, 2,3 and 4 cycles		1	1	1	1	PC	OpCode	1
	(2)	2	1	1	0	PC+1	Offset	1
	(3)	1	1	1	1	New PC	OpCode	1
9b. Relative Bit Branch r BBRx, BBSx 16 OpCodes, 3 bytes, 5,6 and 7 cycles	(2)	1	1	1	1	PC	OpCode	1
	(3)	2	1	1	0	PC+1	zp	1
		3	1	1	0	0,zp	Data	1
		4	1	1	0	PC+2	Offset	1
		5	1	1	0	PC+Offset	New OpCode	1
10a. Stack s ABORTB, IRQB, NMIB, RESB 4 hardware interrupts, 0 bytes, 7 cycles		1	1	1	1	PC	not used	1
		2	1	1	0	PC	not used	1
		3	1	1	0	01,S	Return PCH	0
	(5)	4	1	1	0	01,S-1	Return PCL	0
		5	1	1	0	01,S-2	Return P	0
		6	0	1	0	VA	New PCL	1
		7	0	1	0	VA+1	New PCH	1
		1	1	1	1	New PC	New OpCode	1
10b. Stack (Software Interrupts) s BRK 1 OpCode, 2 bytes, 7 cycles		1	1	1	1	PC	OpCode	1
		2	1	1	0	PC+1	not used	1
		3	1	1	0	S	Return PCH	0
		4	1	1	0	S-1	Return PCL+2	0
		5	1	1	0	S-2	Return P	0
		6	0	1	0	VA	New PCL	1
		7	1	1	1	VA+1	New PCH	1
		1	1	1	1	New PC	New OpCode	1
10c. Stack (Return from interrupt) s RTI 1 OpCode, 1 byte, 6 cycles		1	1	1	1	PC	OpCode	1
		2	1	1	0	PC+1	Not Used	1
		3	1	1	0	S+1	Return P	1
		4	1	1	0	S+2	Return PCL	1
		5	1	1	0	S+3	Return PCH	1
		6	1	1	0	PC+1	IO	1
		1	1	1	1	Return PC	New OpCode	1
10d. Stack (Return from subroutine) s RTS 1 OpCode, 1 byte, 6 cycles		1	1	1	1	PC	OpCode	1
		2	1	1	0	PC+1	not used	1
		3	1	1	0	PC+1	not used	1
		4	1	1	0	S+1	Return PCL	1
		5	1	1	0	S+2	Return PCH	1
		6	1	1	0	PC+1	IO	1
		1	1	1	1	Return PC	New OpCode	1
10e. Stack s PHA, PHP, PHX, PHY 4 OpCodes, 1 byte, 3 cycles		1	1	1	1	PC	OpCode	1
		2	1	1	0	PC+1	not used	1
		3	1	1	0	S	Register Value	0
		1	1	1	1	PC+1	New OpCode	1
10f. Stack s PLA, PLP, PLX, PLY 4 OpCodes, 1 byte, 4 cycles		1	1	1	1	PC	OpCode	1
		2	1	1	0	PC+1	not used	1
		3	1	1	0	PC+1	not used	1
		4	1	1	0	S+1	Register Value	1
		1	1	1	1	PC+1	New OpCode	1
11a. Zero Page zp ADC, AND, BIT, CMP, CPX, CPY, EOR, LDA, LDX, LDY, ORA, SBC, STA, STX, STY, STZ 16 OpCodes, 2 bytes, 3 and 4 cycles		1	1	1	1	PC	OpCode	1
		2	1	1	0	PC+1	zp	1
		3	1	1	0	0,zp	Data	1/0
		1	1	1	1	PC+2	New OpCode	1



Address Mode	Note	Cycle	VPB	MLB	SYNC	Address Bus	Data Bus	RWB
11b. Zero Page zp ASL, DEC, INC, ROL, ROR, TRB, TSB 7 OpCodes		1	1	1	1	PC	OpCode	1
		2	1	1	0	PC+1	zp	1
		3	1	0	0	PC+1	Data	1
		4	1	0	0	zp	not used	1
		5	1	0	0	zp	Data	0
		1	1	1	1	1	PC+2	New OpCode
11c. Zero Page zp RMBx, SMBx 16 OpCodes, 2 bytes, 5 cycles		1	1	1	1	PC	OpCode	1
		2	1	1	0	PC+1	zp	1
		3	1	1	0	zp	Data	1
		4	1	1	0	zp	not used	1
		5	1	1	0	zp	Data	0
11d. Zero Page zp BBRx, BBSt 16 OpCodes, 3 bytes, 5 cycles		1	1	1	1	PC	OpCode	1
		2	1	1	0	PC+1	zp	1
		3	1	1	0	zp	Data	1
		4	1	1	0	PC+2	Offset	1
		5	1	1	0	PC+3	not used	1
		1	1	1	1	1	PC+2+0Offset	New OpCode
12. Zero Page Indexed Indirect (zp,x) ADC, AND, CMP, EOR, LDA, ORA, SBC, STA 8 OpCodes, 1 byte, 5 cycles		1	1	1	1	PC	OpCode	1
		2	1	1	0	PC+1	zp	1
		3	1	1	0	PC+1	not used	1
		4	1	1	0	0,zp+X	Indirect address	1
		5	1	1	0	Indirect address	Data	1
		1	1	1	1	1	PC+1	New OpCode
13a. Zero Page Indexed with X zp,x ADC, AND, BIT, CMP, EOR, LDA, ORA, LDY, SBC, STA, STY, STZ 12 OpCodes, 1 byte, 4 cycles		1	1	1	1	PC	OpCode	1
		2	1	1	0	PC+1	zp	1
		3	1	1	0	PC+1	not used	1
		4	1	1	0	0,zp+X	Data	1/0
		1	1	1	1	1	PC+1	New OpCode
13b. Zero Page Indexed with X zp,x ASL, DEC, INC, LSR, ROL, ROR 6 OpCodes, 1 byte, 6 cycles		1	1	1	1	PC	OpCode	1
		2	1	1	0	PC+1	zp	1
		3	1	1	0	PC+1	not used	1
		4	1	0	0	0,zp+X	Data	1
		5	1	0	0	0,zp+X	not used	1
		6	1	0	0	0,zp+X	Data	0
		1	1	1	1	1	PC+1	New OpCode
14. Zero Page Indexed with Y zp,y ADC, AND, CMP, EOR, LDA, LDX, ORA, SBC, STA, STX 10 OpCodes, 1 byte, 4 cycles		1	1	1	1	PC	OpCode	1
		2	1	1	0	PC+1	zp	1
		3	1	1	0	PC+1	not used	1
		4	1	1	0	0,zp+Y	Data	1/0
		1	1	1	1	1	PC+1	New OpCode
15. Zero Page Indirect (zp) ADC, AND, CMP, EOR, LDA, ORA, SBC, STA 8 OpCodes, 1 byte, 4 cycles		1	1	1	1	PC	OpCode	1
		2	1	1	0	PC+1	zp	1
		3	1	1	0	0,zp	Indirect address	1
		4	1	1	0	Indirect address	Data	1/0
		1	1	1	1	1	PC+1	New OpCode
16. Zero Page Indirect Indexed with y (zp),y ADC, AND, CMP, EOR, LDA, ORA, SBC, STA 8 OpCodes, 1 byte, 4, 5 and 6 cycles		1	1	1	1	PC	OpCode	1
		2	1	1	0	PC+1	zp	1
		3	1	1	0	0,zp	Indirect address HIGH	1
	(6)	4	1	1	0	0,zp+1	Indirect address LOW	1
	(1)	5	1	1	0	Indirect address+y	Data	1/0
		5a	1	1	0	PC+2	New OpCode	1



Notes:

1. Add 1 cycle for indexing across page boundaries, or write. This cycle contains invalid addresses.
2. Add 1 cycle if branch is taken.
3. Add 1 cycle if branch is taken across page boundaries.
4. Wait at cycle 2 for 2 cycles after NMIB or IRQB active input.
5. RWB remains high during Reset.
6. Add 1 cycle for decimal mode

AAH	Absolute Address	PC	Program Counter
AAH	Absolute Address High	PCH	Program Counter High
AAL	Absolute Address Low	PCL	Program Counter Low
AAVH	Absolute Address Vector High	R-M-W	Read-Modify-Write
AAVL	Absolute Address Vector Low	REG	Register
C	Accumulator	S	Stack Address
DEST	Destination	SRC	Source
ID	Immediate Data	SO	Stack Offset
IO	Internal Operation	V	Vector Address
P	Status Register	x,y	Index Register
		zp	Zero Page Address



7 CAVEATS

Table 7-1 Microprocessor Operational Enhancements

Function	NMOS 6502	W65C02S																								
Indexed addressing across page boundary	Extra read of invalid address.	Extra read of last instruction byte.																								
Execution of invalid OpCodes.	Some terminate only by reset. Results are undefined.	All are NOP's (reserved for future use). <table border="1"> <thead> <tr> <th>OpCode</th> <th>Bytes</th> <th>Cycles</th> </tr> </thead> <tbody> <tr> <td>02,22,42,62,82</td> <td>2</td> <td>2</td> </tr> <tr> <td>C2, E2</td> <td></td> <td></td> </tr> <tr> <td>X3,OB-BB,EB,FB</td> <td>1</td> <td>1</td> </tr> <tr> <td>44</td> <td>2</td> <td>3</td> </tr> <tr> <td>54,D4,F4</td> <td>2</td> <td>4</td> </tr> <tr> <td>5C</td> <td>3</td> <td>8</td> </tr> <tr> <td>DC,FC</td> <td>3</td> <td>4</td> </tr> </tbody> </table>	OpCode	Bytes	Cycles	02,22,42,62,82	2	2	C2, E2			X3,OB-BB,EB,FB	1	1	44	2	3	54,D4,F4	2	4	5C	3	8	DC,FC	3	4
OpCode	Bytes	Cycles																								
02,22,42,62,82	2	2																								
C2, E2																										
X3,OB-BB,EB,FB	1	1																								
44	2	3																								
54,D4,F4	2	4																								
5C	3	8																								
DC,FC	3	4																								
Jump indirect, operand = XXFF.	Page address does not increment.	Page address increments, one additional cycle.																								
Read/Modify/Write instruction at effective address.	One read and two write cycles.	Two read and one write cycle.																								
Decimal flag.	Indeterminate after reset.	Initialized to binary mode (D=0) after reset and interrupts.																								
Flags after decimal operation.	Invalid N, V and Z flags.	Valid flags. One additional cycle.																								
Interrupt after fetch of BRK instruction	Interrupt vector is loaded; BRK vector is ignored.	BRK is executed, and then interrupt is executed.																								
Ready.	Input.	Bi-directional, WAI instruction pulls low.																								
Read/Modify/Write instructions absolute indexed in same page.	Seven cycles.	Six cycles.																								
Oscillator.	Requires external active components.	Crystal or RC network will oscillate when connected between PHI2 and PHI10.																								
Assertion of Ready (RDY) during write operations.	Ignored.	Stops processor during PHI2, and WAI instruction pulls RDY low.																								
Clock inputs.	PHI2 is the only required clock.	PHI2 is the only required clock.																								
Unused input-only pins.	Must be tied to VDD.	Must be tied to VDD.																								

The BRK instruction for both the NMOS 6502 and 65C02 is a 2 byte instruction. The NMOS and CMOS devices simply skips the second byte (i.e. doesn't care about the second byte) by incrementing the program counter twice. It is important to realize that if a return from interrupt is used it will return to the location after the second or signature byte.

8 W65C02DB DEVELOPER BOARD AND IN-CIRCUIT EMULATOR (ICE)

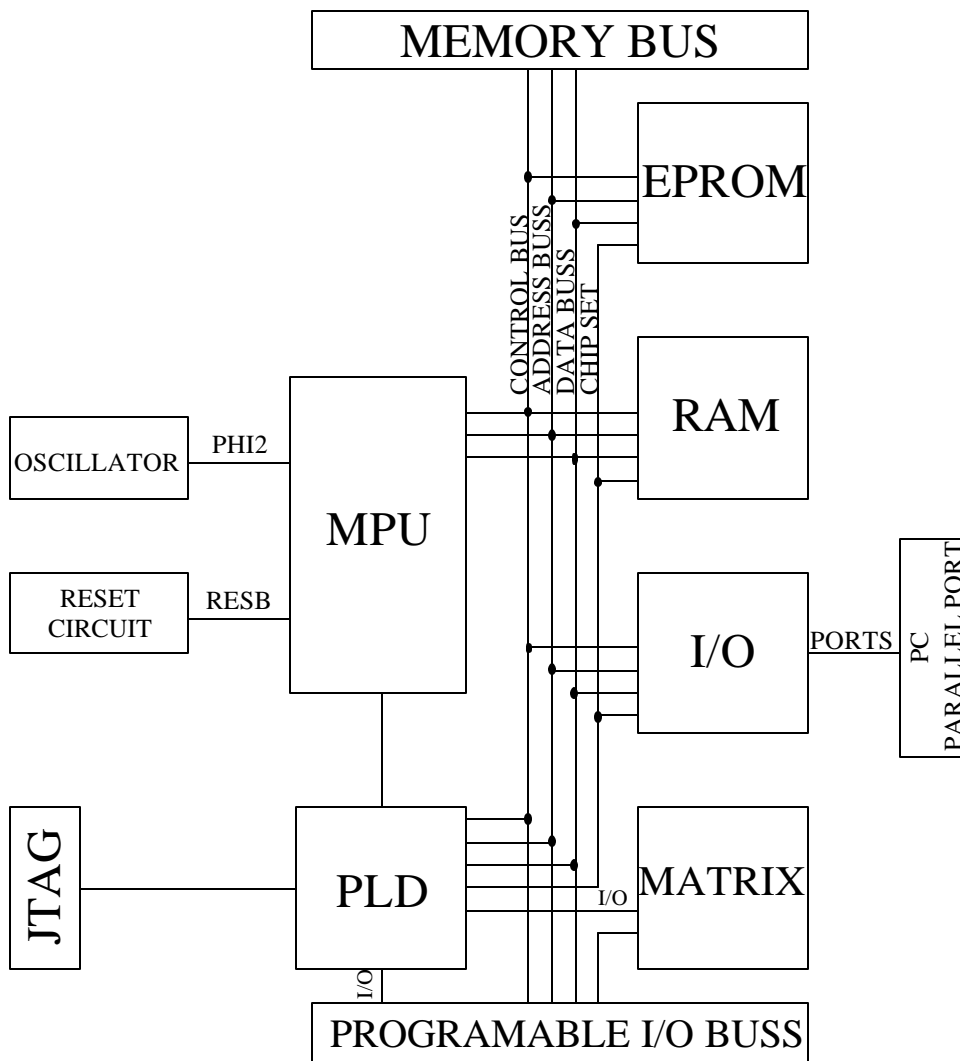

The W65C02DB is used for W65C02 core microprocessor System-Chip Development, W65C02S (chip) System Development, or Embedded W65C02DB (board) Development.



8.1 Features:

W65C02S 8-bit MPU, total access to all control lines, Memory Bus, Programmable I/O Bus, PC Interface, 20 I/O lines, easy oscillator change, 32K SRAM, 32K EPROM, W65C22S Versatile Interface Adapter VIA peripheral chip, on-board matrix, CPLD for Memory map decoding, hardware breakpoints and ASIC design.

The CPLD chip is a XILINX XC95108 for changing the chip select and I/O functions if required. To change the CPLD chip to suit your own setup, you need XILINX Data Manager for the XC95108 CPLD chip. The W65C02DB includes an on-board programming header for JTAG configuration. For more details refer to the circuit diagram. The on-board W65C02S and the W65C22S devices have measurement points for core power consumption. Power input is provided by an optional power board which plugs into the 10 pin power header.

An EPROM programmer or an EPROM emulator is required to reprogram the EPROM. WDC's (W65SDS) Software Development System includes a W65C02S Assembler and Linker, W65C02S C-Compiler and Optimizer, and W65C02S Simulator/Debugger. WDC's PC IO daughter board can be used to connect the Developer Board to the parallel port of a PC for In-Circuit Debugging.

8.2 Memory map:

CS1B:	8000-FFFF	⇒	EPROM (27C256)
CS3B:	0000-00EF & 0100-7FFF	⇒	SRAM (62C256)
CS2B:	00F0-00FF	⇒	VIA(W65C22S)

8.3 Cross-Debugging Monitor Program

The Cross-Debugging Monitor Programs of the Developer Boards are located in the directory <drive>:\WDC_SDS\DEBUG\WDCMON\

This directory contains the source and the batch files for all of the monitor programs. These programs can be burned into an EPROM and used with the WDC evaluation boards (Developer Boards) and the WDC IO (or ZIO-1) daughter board to interface to the parallel port of a PC. Then, the WDCDB.EXE debugger can be used to download programs, single step, set breakpoints, examine memory, etc for In-Circuit Debugging (ICD).

The monitors have been designed to run correctly with a W65C02 MPU (WDCMON_1), W65C816 MPU (WDCMON_2), W65C134 MCU (WDC134), or W65C265 MCU (WDC265). It detects the appropriate CPU type on RESET and operates accordingly.

8.4 BUILDING

The batch files assemble the program and link it producing Motorola S-Record output. This can be changed by using a different option with the WDCLN linker



9 HARD CORE MODEL

9.1 Features of the W65C02S Hard Core Model

- The W65C02S core uses the same instruction set as the W65C02S.
- The only functional difference between the W65C02S and W65C02S core is the RDY pin. The W65C02S RDY pin is bi-directional utilizing an active pull-up. The W65C02S core RDY function is split into 2 pins, RDY, WAITN and WAITP. The WAITN output goes low and WAITP goes high when a WAI instruction is executed.
- The ESD and latch-up buffers have been removed.
- The output from the core is the buffer N-channel and the P-channel transistor drivers.
- The following inputs, if not used, must be pulled to the high state: RDY, IRQB, NMIB, BE and SOB.
- The timing of the W65C02S core is the same as the W65C02S.

10 SOFT CORE RTL MODEL

10.1 W65C02 Synthesizable RTL-Code in Verilog HDL

The RTL-Code (**R**egister **T**ransfer **L**evel) in Verilog is a synthesizable model. The behavior of this model is equivalent to the original W65C02S hardcore. The W65C02 RTL-Code is available as the core model and the W65C02S standard chip model. The standard chip model includes the soft-core and the buffer ring in RTL-Code.



ORDERING INFORMATION

W65C02S6PL-14	
Description W65C = standard product	W65C
Product Identification Number	02S
Foundry Process Blank = 1.2u 8=.8u, 6=.6u	6
Package P = Plastic Dual-In-Line, 40 pins PL = Plastic Leaded Chip Carrier, 44 pins Q = Quad Flat Pack, 44 pins	PL
Temperature/Processing Blank = -40°C to + 85°C (PLCC and QFP) 0°C to 70°C (DIP)	
Speed Designator -14 = 14MHz	-14

To receive general sales or technical support on standard product or information about our module library licenses, contact us at:

The Western Design Center, Inc.
 2166 East Brown Road
 Mesa, Arizona 85213 USA
 Phone: 480-962-4545 Fax: 480-835-6442
 information@westerndesigncenter.com
 www.westerndesigncenter.com

WARNING: MOS CIRCUITS ARE SUBJECT TO DAMAGE FROM STATIC DISCHARGE

Internal static discharge circuits are provided to minimize part damage due to environmental static electrical charge build-ups. Industry established recommendations for handling MOS circuits include:

1. Ship and store product in conductive shipping tubes or conductive foam plastic. Never ship or store product in non-conductive plastic containers or non-conductive plastic foam material.
2. Handle MOS parts only at conductive work stations.
3. Ground all assembly and repair tools.